

# ADVANCED HIGH CEILING Atria 10 Series - Adjustable Cable



## IMPORTANT SAFETY INFORMATION. READ AND FOLLOW ALL SAFETY INSTRUCTIONS

IMPORTANT SAFETY INFORMATION. READ AND FOLLOW ALL SAFETY INSTRUCTIONS. Before wiring to power supply and during servicing or relamping, turn off power at fuse or circuit breaker. All servicing or relamping must be performed by qualified service personnel. Product must be grounded to avoid potential electric shock or other potential hazard. Product must be at locations and at heights and in a manner consistent with its intended use, and in compliance with Electrical Code and local codes.

**SAVE THESE INSTRUCTIONS FOR FUTURE REFERENCE.**

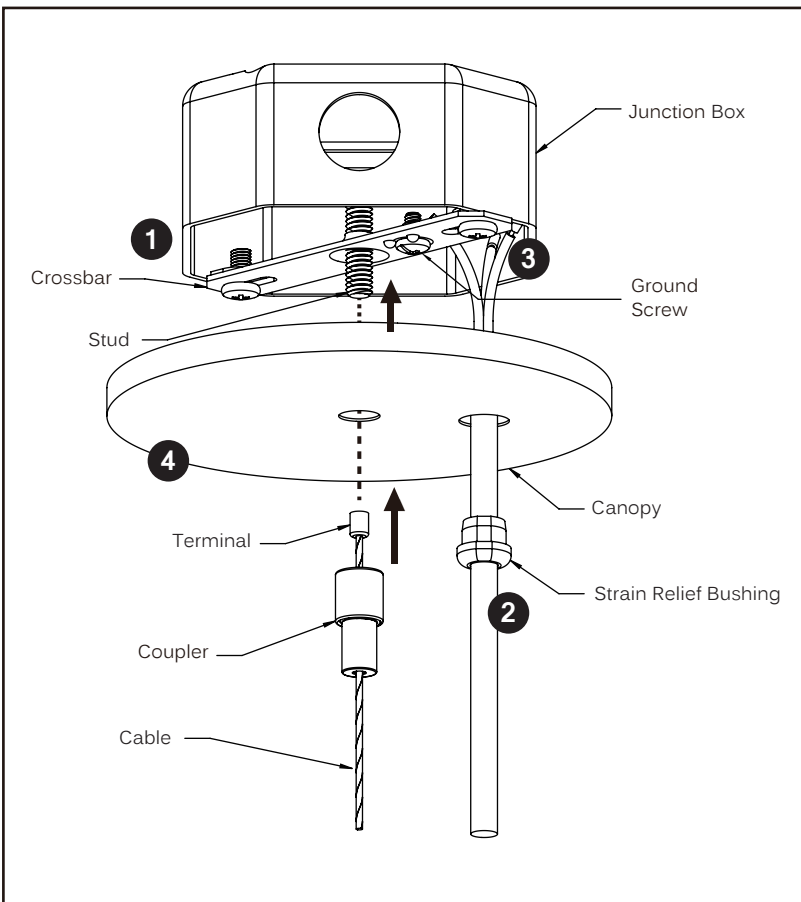

### Step 1

Secure the crossbar to the 4" octagonal box (by others) designed to support the weight of the fixture.

### Step 2

Lock the strain relief bushing to the power cord with allowance for wiring connections, and thread the power cord through the canopy wire hole.

### Step 3

Connect the Green ground conductor to the ground screw on the crossbar, the line voltage to the Black conductor, and the neutral to the White conductor. For 0-10V dimming option, connect the two remaining conductors (Data+ to Purple conductor and Data- to Gray conductor).

\* Make all connections with UL approved connectors.

### Step 4

Thread the cable through the coupler with the terminal side on top. Slide the coupler up to the canopy and secure with the stud on crossbar.

# ADVANCED HIGH CEILING Atria 10 Series - Adjustable Cable

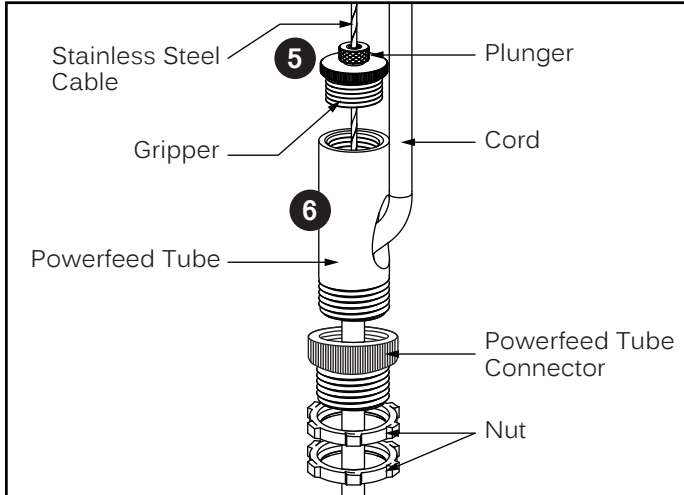

## Step 5

Insert the cable through the gripper and plunger. Trim off extra cable using cable cutting tool. To adjust the cable to desired length, press the plunger.

## Step 6

Fasten Powerfeed tube and Powerfeed tube connector. Secure gripper with Powerfeed tube, then feed cord through Powerfeed tube.

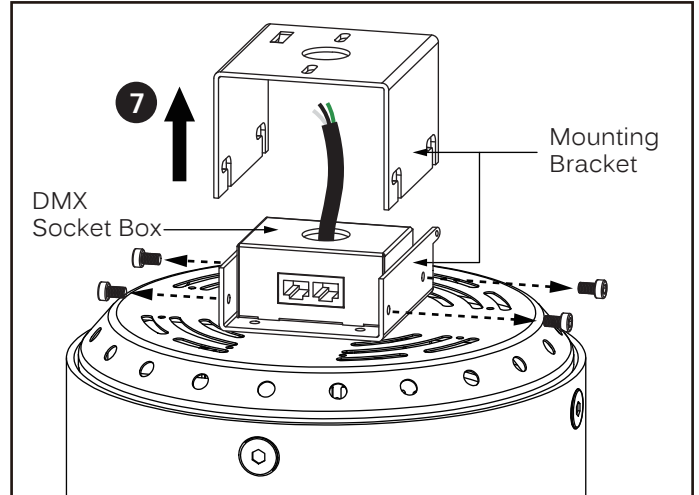

## Step 7

Loosen the 4 philips screws on the side of the fixture and remove the mounting bracket.

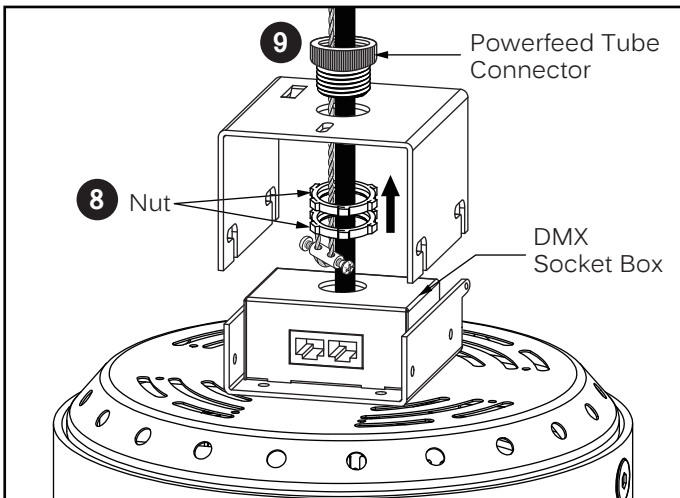

## Step 8

Insert Wire cable and safety cable through the 2 screw nuts placed on one side of the mounting bracket.

## Step 9

Insert both wire cable and safety cable through the powerfeed tube connector on the other side of the mounting bracket.

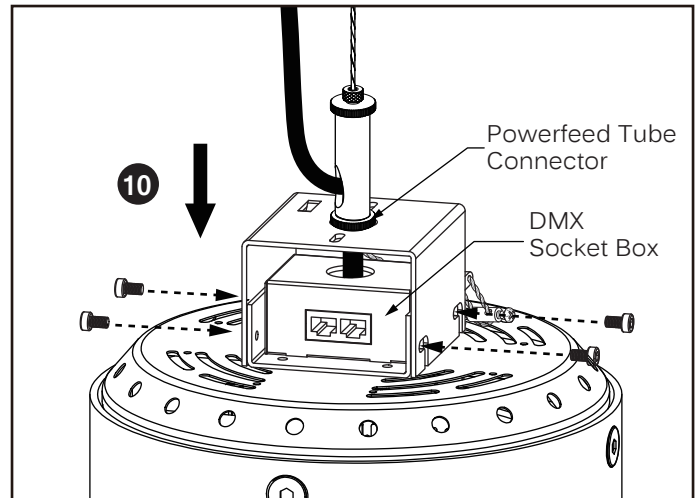

## Step 10

Screw in the earlier loosened 4 philips screws to the side of the fixture, including the safety cable.

# ADVANCED HIGH CEILING Atria 10 Series - Adjustable Cable



## Wiring Diagram Note: 180W/220W use two power cable.

### 0-10V / Superior 0-10V

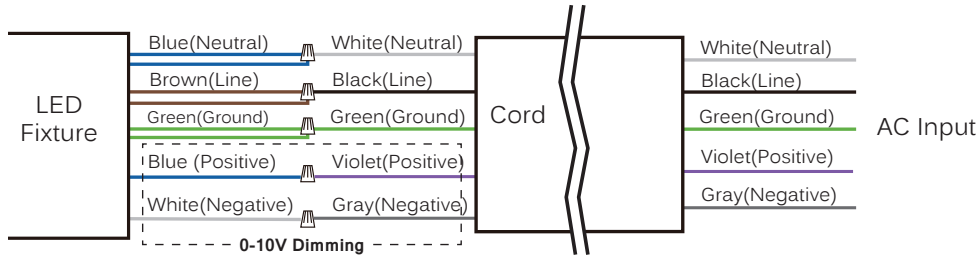

### DMX

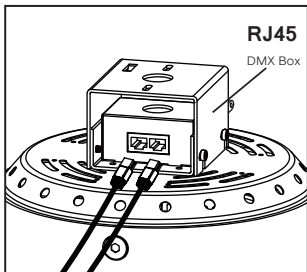
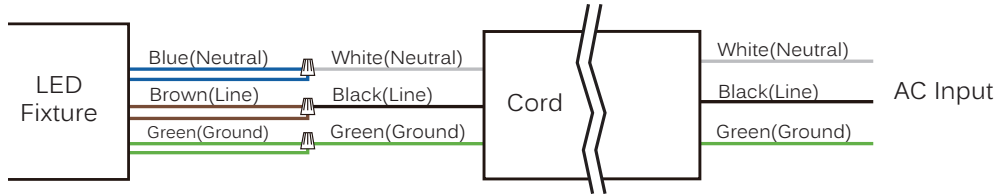

Connect DMX by using a standard shielded CAT5/6 cable.

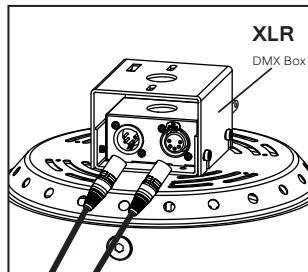

Connect DMX by using a standard DMX512 XLR cable with 5 pin in/out connector (by others).

**\*The last fixture has to be terminated with a DMX Terminator (by others).**

# ADVANCED HIGH CEILING

## Atria 10 Series - Adjustable Cable

---



### Application note : Wiring for DMX/RDM lighting systems

DMX/RDM is a robust and reliable system for lighting control. However, if not implemented correctly, problems can arise such as random flashing of lights, erratic operation and delays in responding to commands. This document explains the best practices in DMX wiring.

### Important things to consider are:

1. DMX is a three-wire system. Use all three!
2. DMX is based on the EIA-485/RS-485 standard.
3. Always use cable specifically designed for DMX / RS-485. These cables have an impedance of  $120\Omega$  and a low capacitance. For instance : Belden 9841 or 3105a.
4. DMX must be terminated with a  $120\Omega$  resistor to prevent reflections.
5. A daisy chain topology should be used.
6. After **32** unit loads a repeater/booster should be used.  
(Important : For tunable white fixtures, After "**15**" unit loads a repeater/booster should be used.)
7. Keep cabling below 200 meters between the controller and the last driver.
8. It is generally considered good practice to provide separate DMX in and DMX out / DMX thru connections to your fixture to aid in installation. This can be in the form of pigtailed, RJ-45 connectors or 5-pin XLR connectors.
9. Use twisted pair cables with an impedance of  $120\Omega$  and a low capacitance.
10. UTP Cat5 or Cat6 network cable can also be used but have a slightly lower impedance of  $100\Omega$ .
11. If shielded cable is used, only connect shield to ground on one side (typically, the controller should have its shield terminal connected to ground).
12. Not following the above recommendations may seem to work at first, but can cause problems. Sometimes after weeks of seemingly normal operation.